



QUARTER ROUNDS



Quarter rounds are a general purpose moulding with a wide variety of uses. Quarter rounds are frequently used as an inside corner trim and as a stop.



QR 1/4
FO 1/4



QR 5/16
FO 5/16



QR 3/8
FO 3/8



QR 7/16
FO 7/16



QR 1/2
FO 1/2



QR 5/8
FO 5/8



QR 3/4
FO 3/4

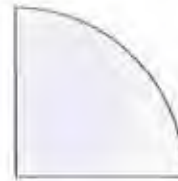

QR 7/8
FO 7/8



QR 1.00
FO 1

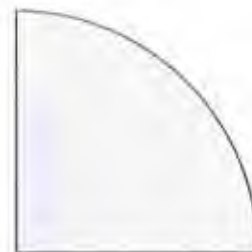

QR 1.25
FO 1 1/4

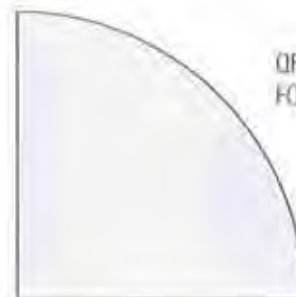

QR 1.50
FO 1 1/2

SHOWN FULL SCALE



STAIR PARTS

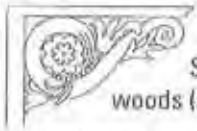

Stair parts are available in a variety of woods (solid or laminated).

Rabbit dimension shown is maximum. Specify rabbit size when ordering. Standard rabbets are 3/8" deep by following widths: 1-1/8", 1-1/4", 1-3/8", 1-7/16", 1-1/2", 1-3/4".

Custom box newels are also available.

See accessories for newel balls and newel caps.



182 HARTLEY
2 3/8 X 3 3/8



973 CHESHIER
1 3/8 X 5 3/8



833 SAGINAW
1 7/16 X 3 1/2



021 REGENCY
FO 2 3/8 X 2 3/8

984 FLAIBAN
1 11/16 X 4

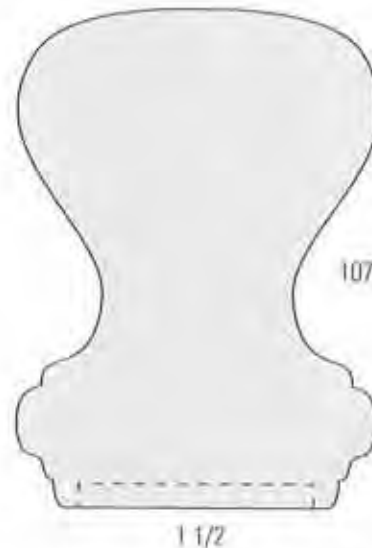
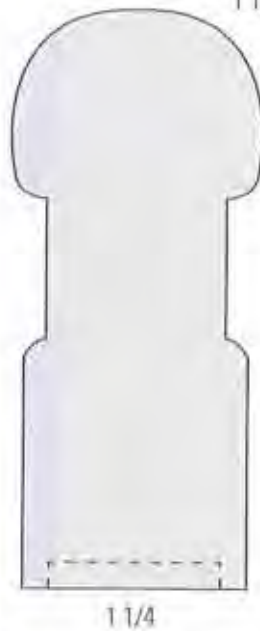

1072 INGLETON
2 1/2 X 3 7/16



1043 BREADLOAF
1 1/4 X 2 1/4

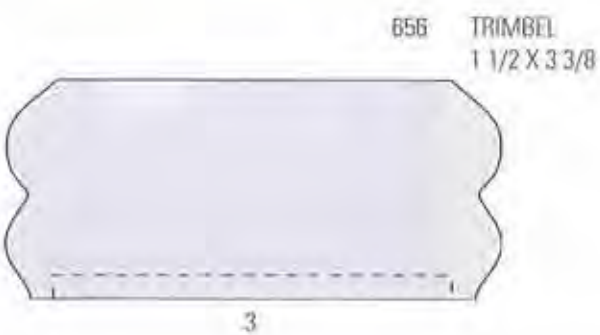
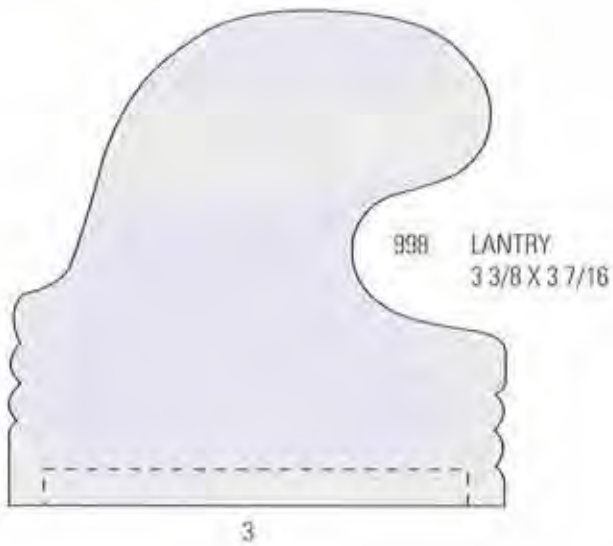
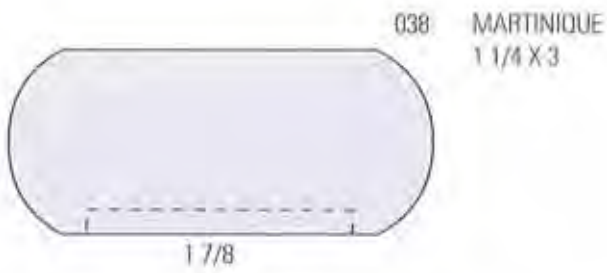
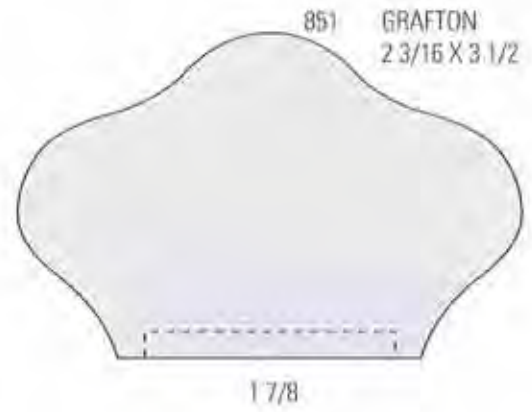
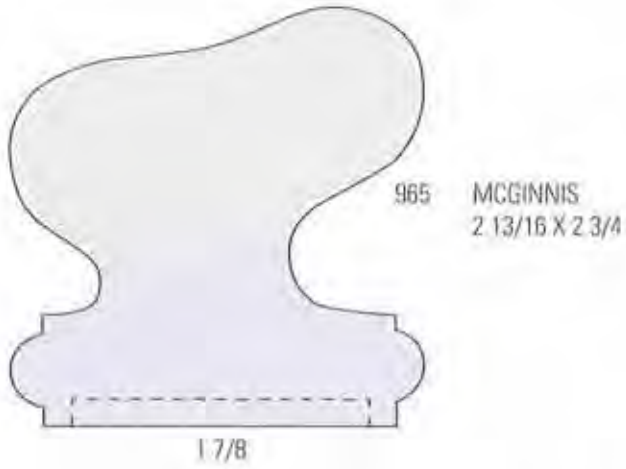



EXTERIOR MOULDINGS

084 DOLLY VARDEN
1 1/16 X 3 1/2



596 ARCHER
1 1/16 X 5 1/2



686 PARRAVANO
7/8 X 5 1/2



109 ULYSSES II DRIP CAP
F. 1 7/16 X 2 1/2



119 DRIP CAP
1 1/4 X 2 1/2



457 DRIP CAP
1 1/4 X 3 1/2



105 DERWOOD
2 X 3 1/4



904 KOTKIN
2 5/8 X 3 1/2



989 OSTEN
2 1/8 X 3 1/2

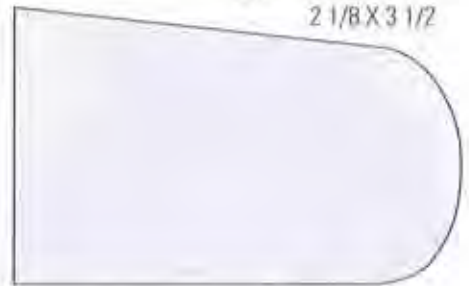

699 BEASLEY
2 1/2 X 3 1/2



Illustrations are 3/4 Scale



MISCELLANEOUS MOULDINGS



924 ATWELL
1 1/16 X 2 11/16



962 LODERMEIER
1 1/16 X 3 7/16



388 LANKA CABINET
7/8 X 1 13/16



883 POLLOCK
7/8 X 2 1/4



858 BIONDI
7/8 X 3 1/4



937 WEIGEL
7/8 X 3 1/2



855 CARVER
13/16 X 6

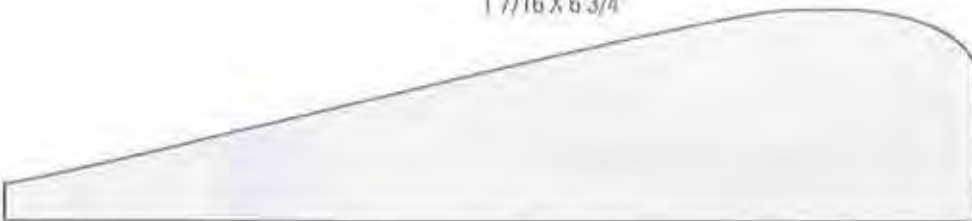

894 TINTORETTO
1 7/16 X 6 3/4



908 BISMARCK
2 1/16 X 2 1/2



915 CHAGNON
7/8 X 3



918 MALLACA
15/16 X 3 1/4



966 RHYNEHART
1 1/8 X 2 5/8



975 BRANDSEN
7/8 X 3 1/4



1047 SPRECHER
3/4 X 3 1/2

Illustrations are 3/4 Scale

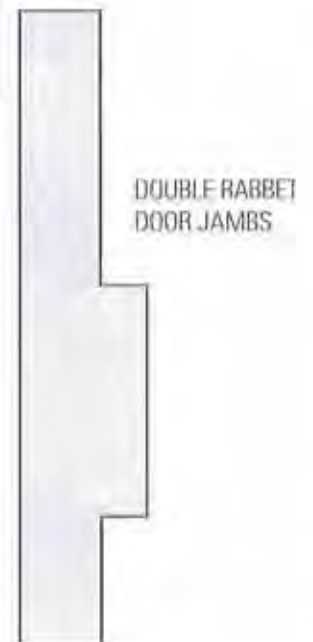
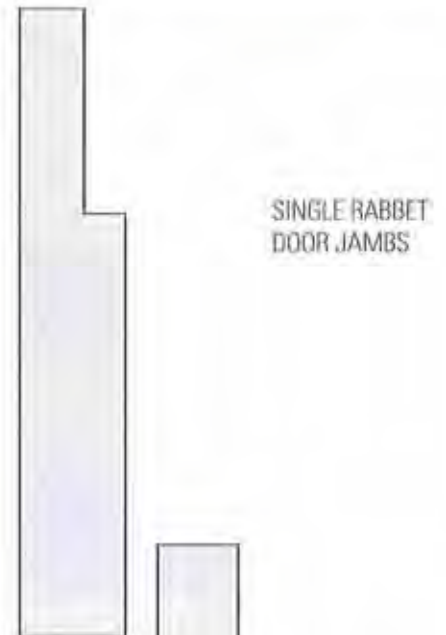
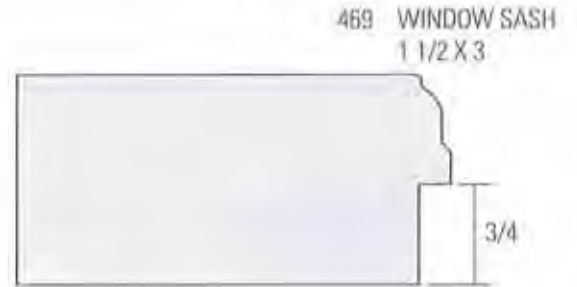
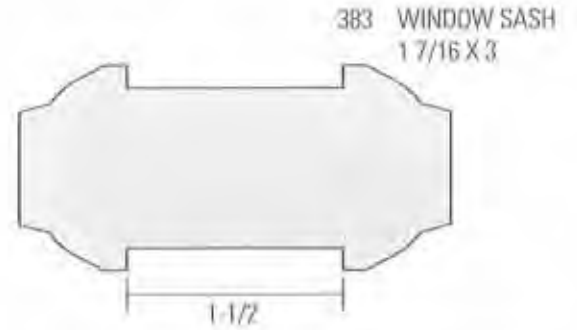
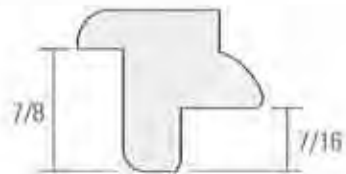
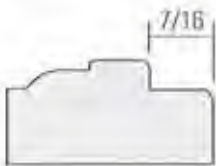
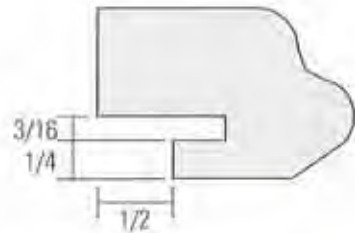
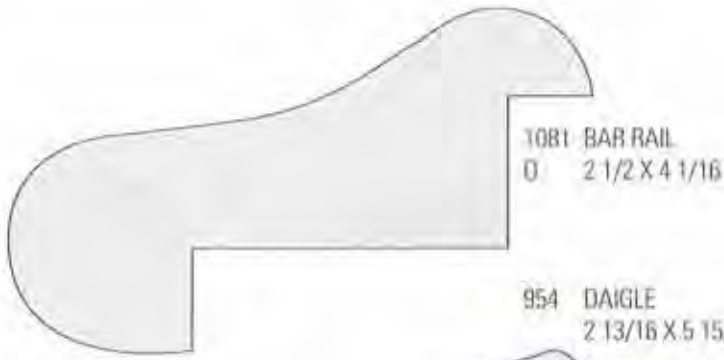



BULLEYES

Bullseyes, or corner blocks, are used to join casing legs, headers, and aprons. Bullseyes are also used to join chair rails to casings. (See illustration on page 96).

Bullseyes are stocked in fir, oak, alder and MDF. They are available in your choice of wood.

Bullseyes are made 15/16" thick. Custom sizes available in most styles.

If a bullseye has an edge detail, a 3/4" minimum is maintained for butting the casing.

Bullseye profiles can be combined with baseblocks to make head blocks. (See illustration on page 94).

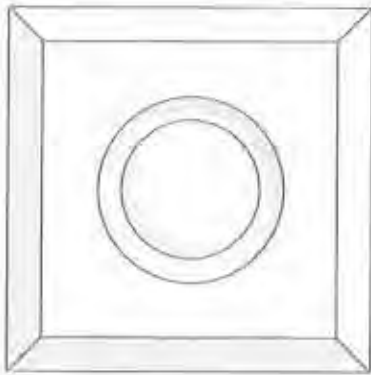

BE 350 AM 3 1/2
BE 450 AM 4 1/2
BE 550 AM 5 1/2

AMHURST

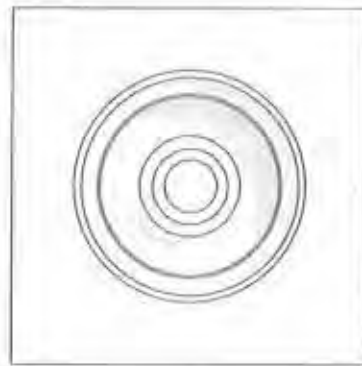

BE 550BO 5 1/2

BOGART

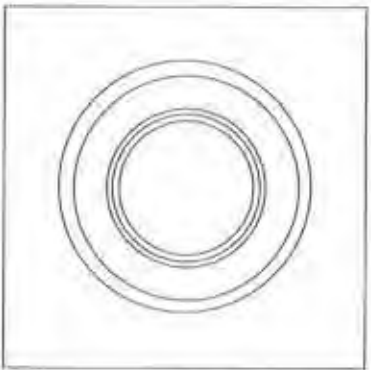

BE 450AP 4 1/2
BE 550AP 5 1/2

APPLIQUE

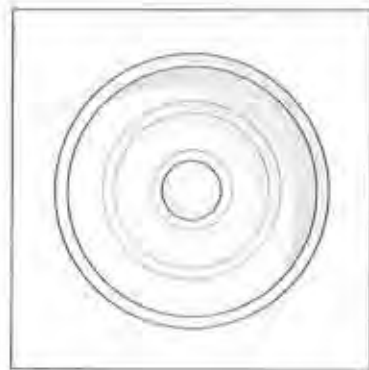

BE 550CA 5 1/2

CARMEL

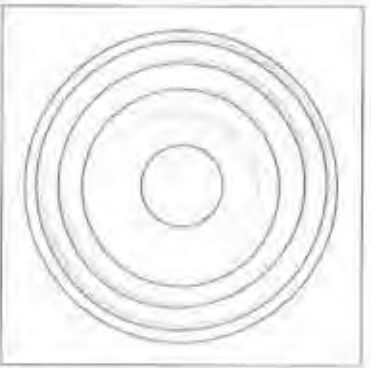

BE 550BE 5 1/2

BEAUMONT

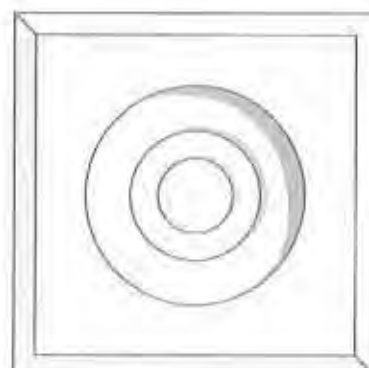

BE 500CO 5

COLLIER

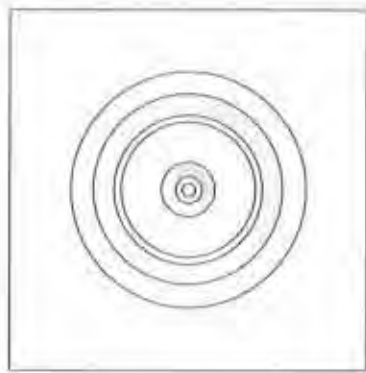

BE 400DA 4
BE 550DA 5 1/2

DANTE

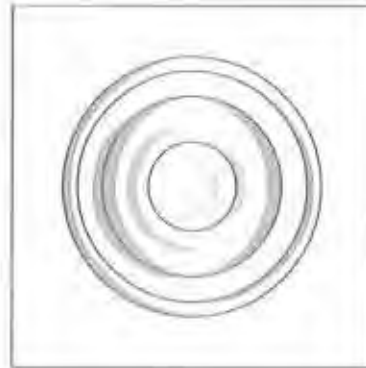

BE 350GO 3 1/2

GORGONIO

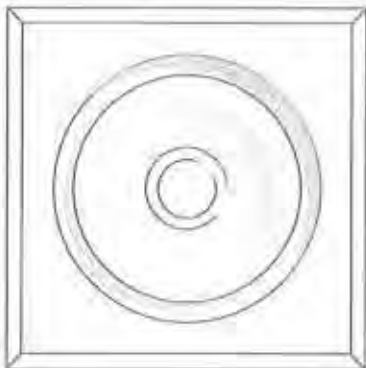

BE 250DI 2 1/2
BE 300DI 3
BE 350DI 3 1/2
BE 400DI 4
BE 450DI 4 1/2
BE 500DI 5
BE 550DI 5 1/2

DIANA

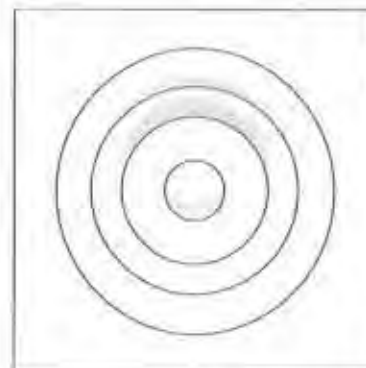

BE 250GR 2 1/2
BE 300GR 3
BE 350GR 3 1/2
BE 400GR 4
BE 450GR 4 1/2
BE 500GR 5
BE 550GR 5 1/2

GRETA

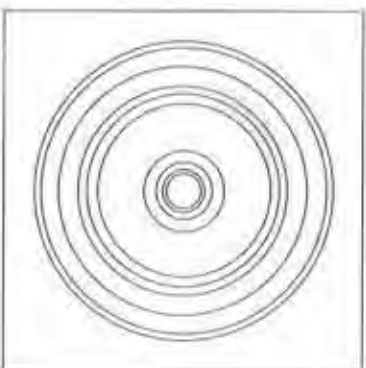

BE 550EL 5 1/2

ELLSWORTH

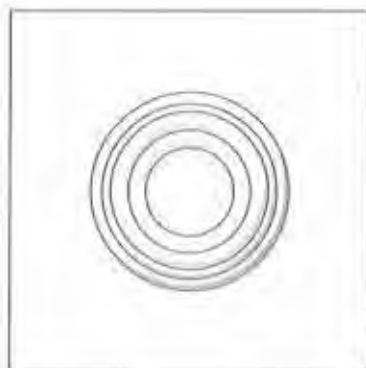

BE 500HA 5

HADLEY



RAINBOW CORNERS

Rainbow corners are used in the same way as bullseyes to create a unique, custom look.

Rainbow corners are made 15/16" or 11/16" thick to match moulding thickness. (See illustration below).



WINDSOR
RC250WI 2 1/2
RC350WI 3 1/2
RC450WI 4 1/2



WILHEMINA
RC350WH 3 1/2



CAMILLA
RC350CA 3 1/2



ODYSSEY
RC250OD 2 1/2
RC350OD 3 1/2
RC450OD 4 1/2



ROSETTES

Rosettes are decorative items applied to cabinetry, mantels, door/window mantels, etc.

Rosettes can be incorporated into your moulding system to create a signature.

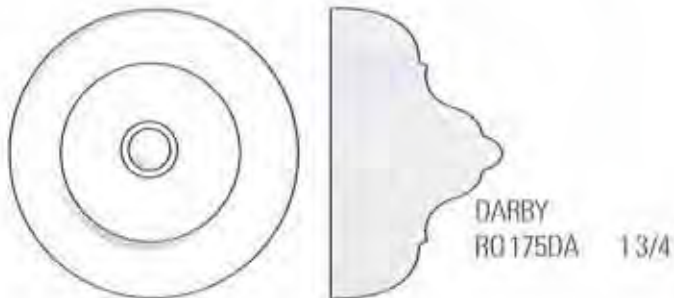
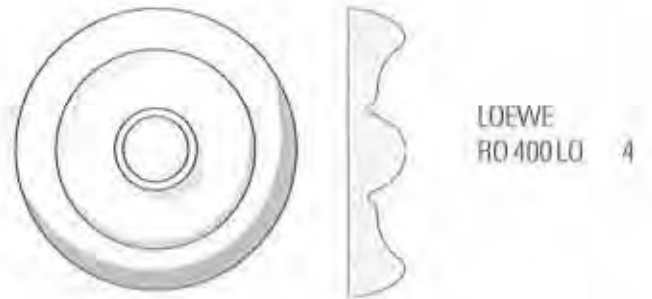
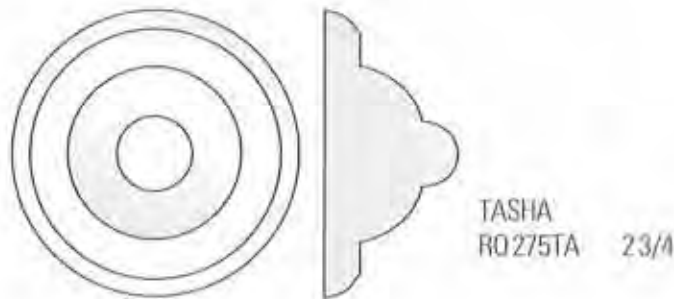
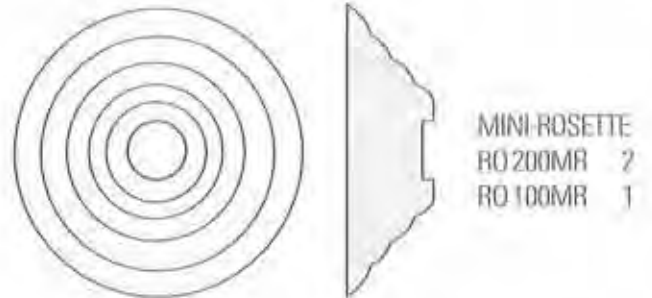
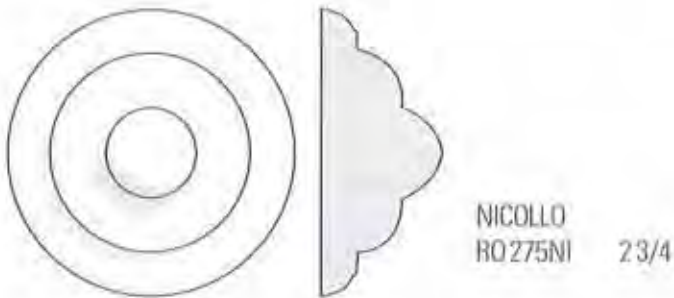



HEAD BLOCKS

Head blocks are used as corner blocks.

Headblocks can be made from any baseblock profile and bullseye profile combination.

Other mouldings can also be used to create headblocks. The Lionel headblock is a combination of Hellenes chair rail #141 and a bullseye.

Please specify size and profile numbers when ordering headblocks.

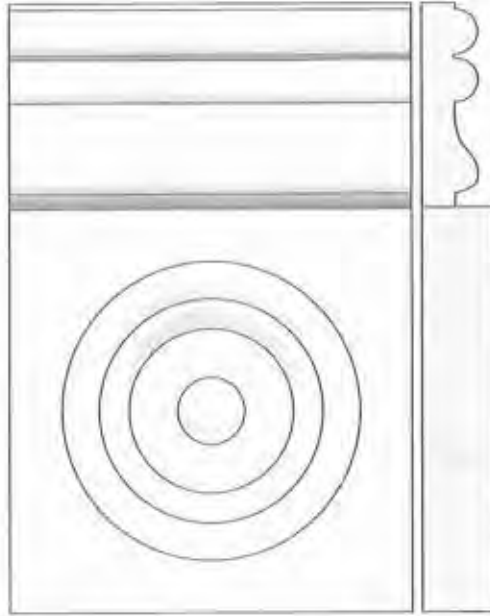

LIONEL HEAD BLOCK

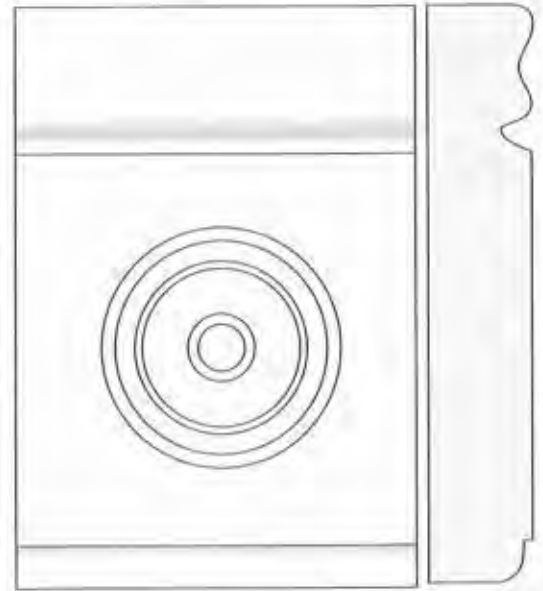

557 KIRSTNER HEAD BLOCK
Thickness - 1-1/8"
Height - 8-3/8"

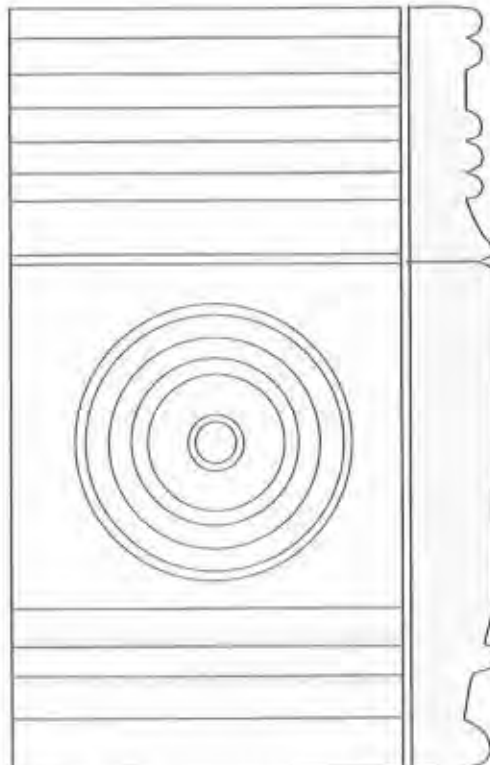

#1078/1079 BELLINGHAM
Thickness - 1-3/8"
Height - 10" - 13"

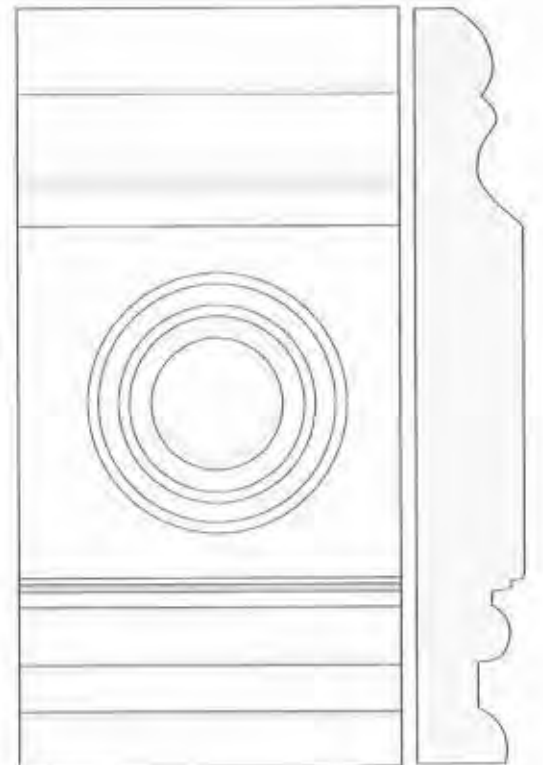

#890 TALBERT
Thickness - 1 1/8"
Height - 10 1/8"



KEYSTONES

Keystones can be made in many sizes, shapes and with a variety of edge details.

Keystone size depends on casing size. Use the following guidelines to calculate keystone dimensions:



$A = .65 \times \text{casing width}$
 $B = 1.5 \times \text{casing width}$
 $C = 1.2 \times \text{casing width}$

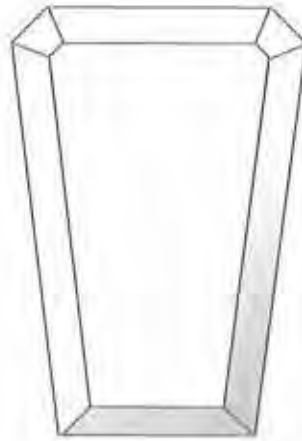

KS1 KEYSTONE

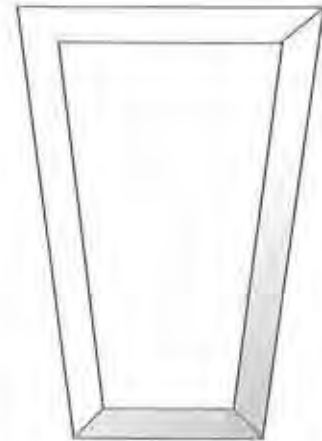

KS2 KEYSTONE



NOTES



BASE BLOCKS

267 TARKINGTON



310 REGENCY

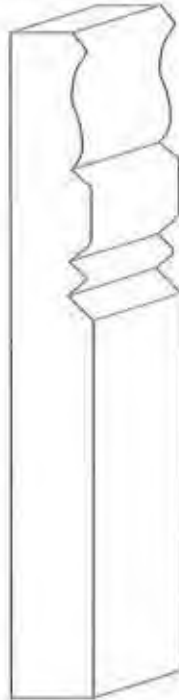

360 PHILLIPS

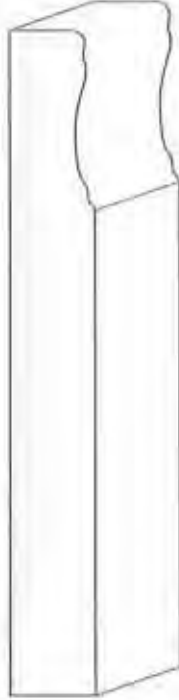

Base blocks are used at the base of door casings. Base blocks allow the use of symmetrical casings by providing the necessary "reveal" for the base board. (See illustration below).

Stock sizes:

Width	Height
2-1/2	6 / 8 / 10-1/4
3	8 / 10-1/4
3-1/2	8 / 10-1/4
4	10-1/4
4-1/2	10-1/4
5	10-1/4
5-1/2	10-1/4

Base blocks are stocked in fir and oak and are available in a variety of woods. Custom sizes are available.

375 BAVARIA

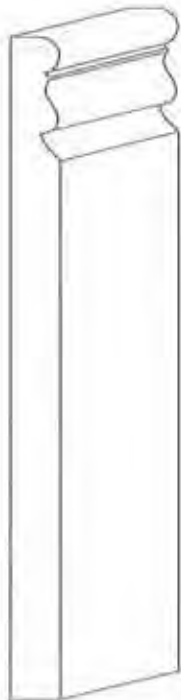

409 MALABAR

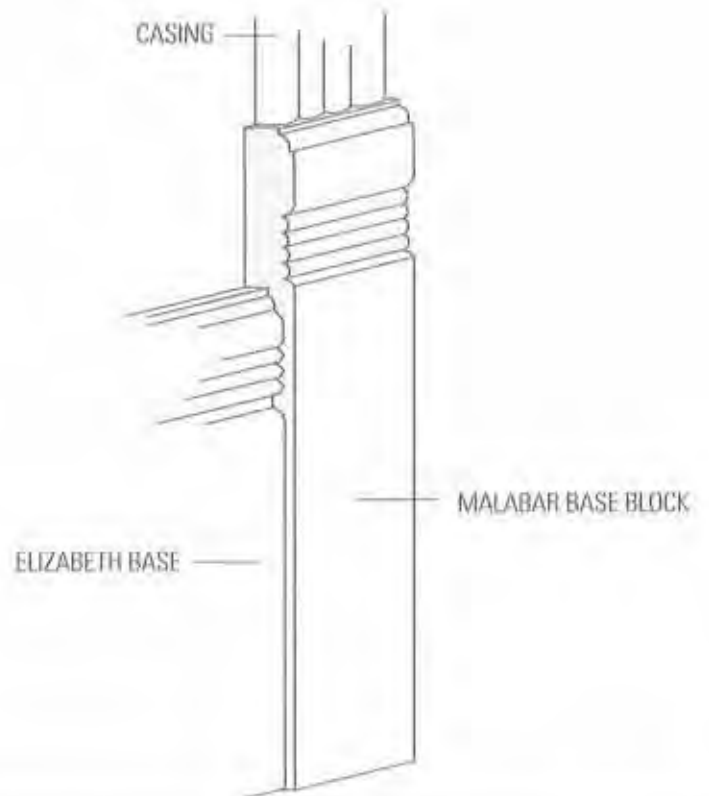
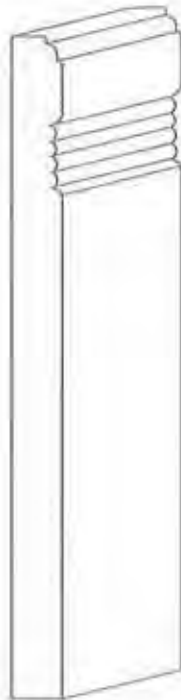

494 NAHIL



509 CALDWELL



597 SCOTTSDALE



684 VERDI

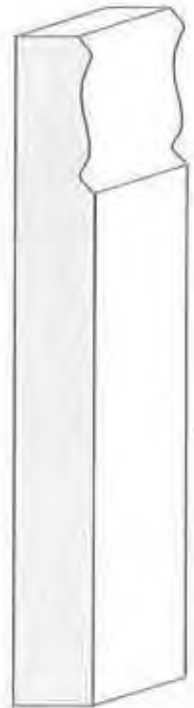

FOOTBLOCKS

789 REINHOLT



891 AVERILL



988 MATTHEE

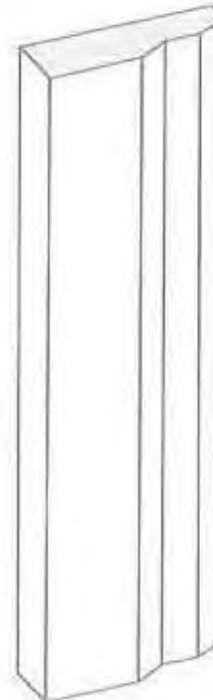

1019 HAMPTON

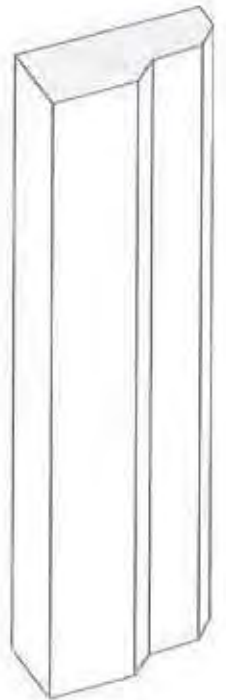

1 3/8 X 4 3/8

1 X 4 7/8



Newel balls and urn tops are available for interior or exterior applications. Please specify usage.

Newel caps are used to cap posts. Newel caps can be used alone or under newel balls or urn tops.

Standard newel cap sizes are 3-3/4 and 5-3/4 inches square. Custom sizes are available.

NEWELBALLS

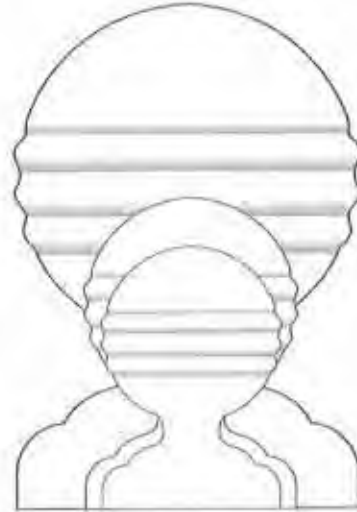

NEWEL BALLS
 NB-2 2 3/4 X 3 7/8
 NB-3 3 1/4 X 4 5/8
 NB-5 5 1/4 X 7 1/2

NEWELCAPS



017 CHIPPENDALE NEWEL CAP

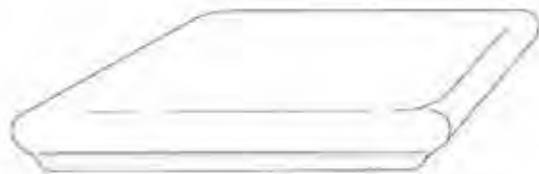

082 FRENCH NEWEL CAP



024 GEORGIAN NEWEL CAP

URN TOPS

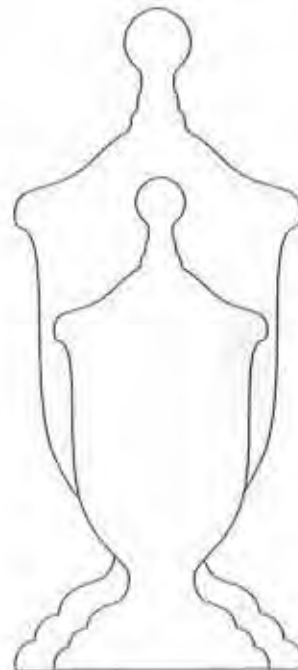

URN TOPS
 UTW-3 3 X 7
 LTH-3 3 X 7 (HALF URN)
 UTW-4 4 X 9 1/2
 LTH-4 4 X 9 1/2 (HALF URN)



PLATE RAILS/SHELVES

Plate rails/shelves provide a place to display plates and other collectibles. You can combine the plate shelf (796) with a variety of mouldings to create a plate shelf combination.

(See illustration).

797 PLATE SELF SUPPORT
1 1/16 X 3 7/16



796 PLATE RAIL
1 1/16 X 3 7/16



461 PLATE RAIL
3/4 X 3 7/16

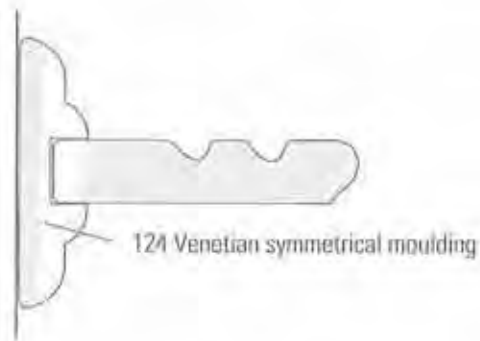
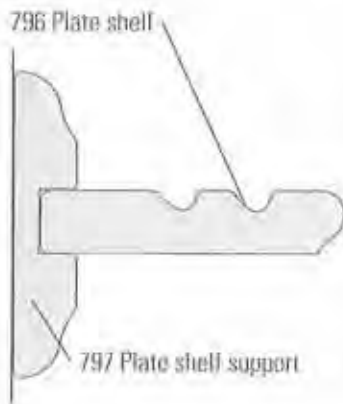



CORBELS

Corbels are used to decorate doorways, porches and support shelves.

As always, alterations are welcome, and we will build custom corbels.

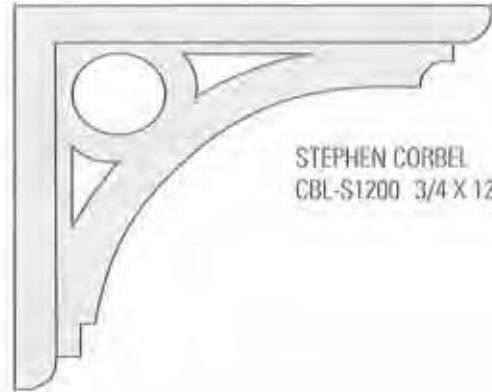

STEPHEN CORBEL
CBL-S1200 3/4 X 12 X 15

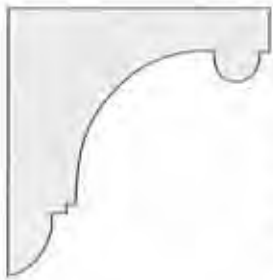

MELISSA CORBEL
CBL-M450 3/4 X 4 1/2 X 4 1/2
CBL-M600 3/4 X 6 X 6
CBL-M775 3/4 X 7 3/4 X 7 3/4
(NAILING FLANGE OPTIONAL)



FLORENTINE CORBEL
CBL-F1250 3/4 X 12 1/2 X 16 1/2



CAMEO CORBEL
CBL-C900 9 X 9
(NAILING FLANGE OPTIONAL)

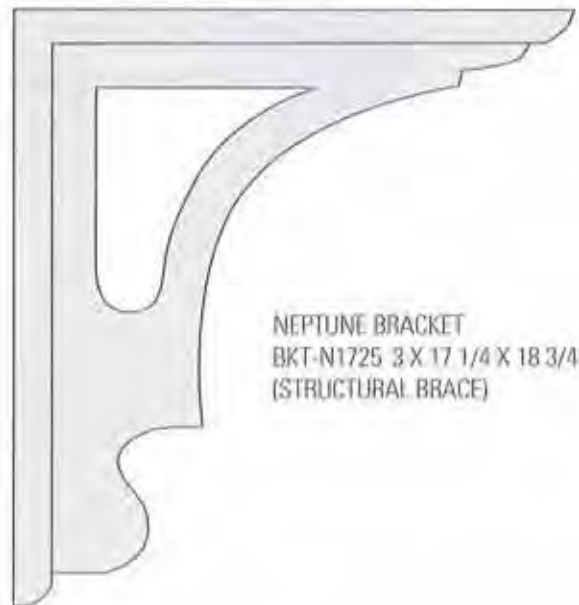

NEPTUNE BRACKET
BKT-N1725 3 X 17 1/4 X 18 3/4
(STRUCTURAL BRACE)

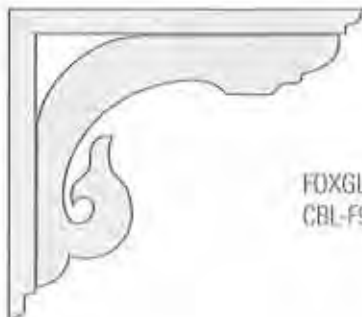

FOXGLOVE CORBEL
CBL-F950 3/4 X 9 1/2 X 11



FIREPLACE MANTELS

Arvid's Woods builds custom fireplace mantels. Using the mouldings and accessories in this catalog, we are able to duplicate most built-up fireplace mantel designs.

Choose a design from Arvid's Woods' Catalog or bring or send us a picture or line drawing from which to build your fireplace mantel. Our sales staff can also assist you in the design of a mantel that is distinctively yours.

Mantel kits are also available. Included in a Arvid's Woods' mantel kit are instructions, drawings, and the mouldings needed to build a fireplace mantel. You provide the sheet goods and/or flat stock and do the assembly. Arvid's staff can answer any questions you have regarding the fireplace mantel assembly on our toll-free telephone lines.

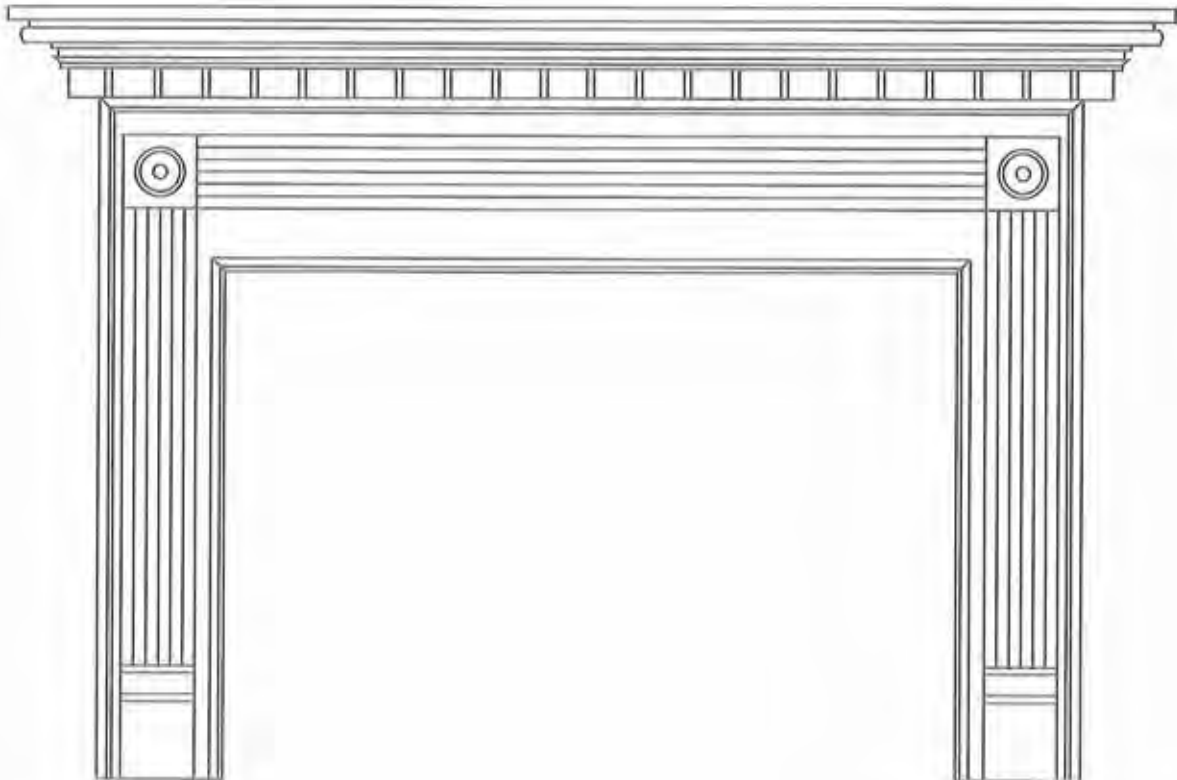

The Arlington
MTL-ARL

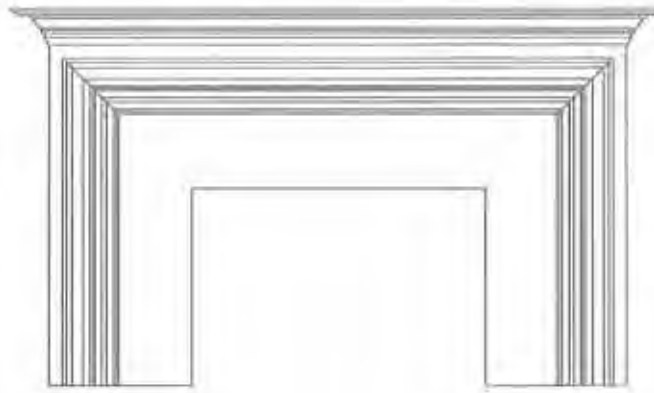

The Arlington features a traditional shelf and a mantel moulding (ex: 298) built up from the mantel front and mitered across the breast board.

The Bellingham
MTL-BEL

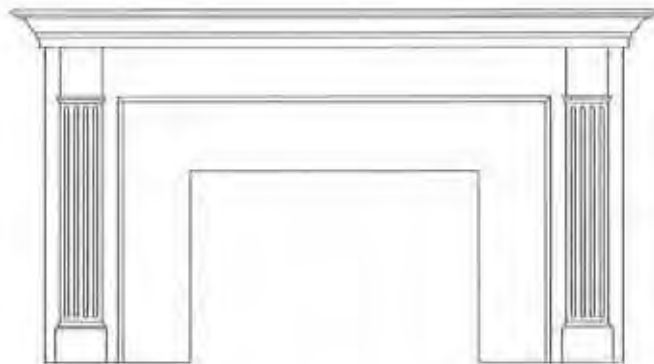

The Bellingham has a traditional shelf and symmetrical casing columns (ex: 003). Appliques or bullseyes can be added to capitals.

The Ellensburg
MTL-ELL

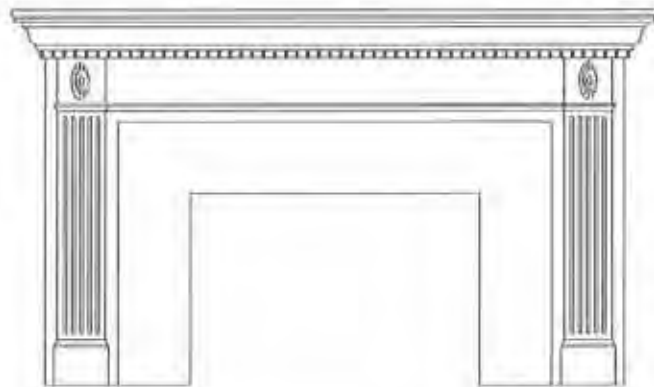

The Ellensburg has fluted columns. Dentil is placed below the mantel shelf and an oval applique is placed on the capital.

The Longview
MTL-LON

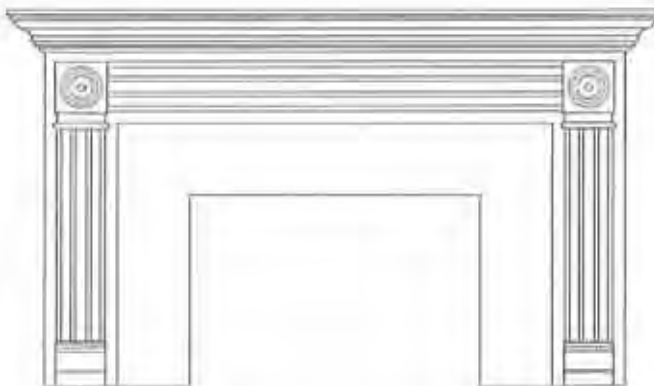

The Longview uses a large symmetrical moulding (ex: 035) on the columns and across the breast board. Bullseyes are used on the capitals.

The Mt. Vernon
MTL-MTV

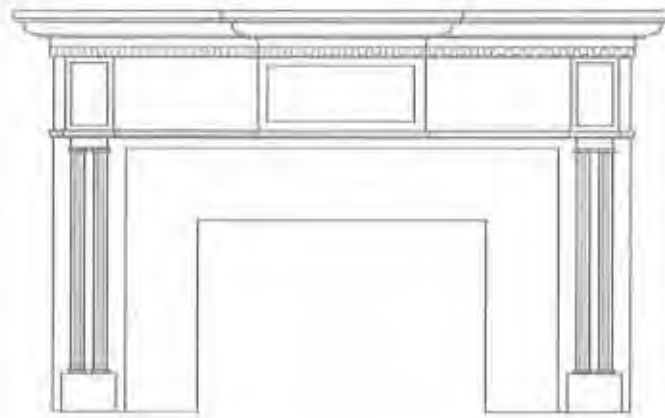

The Mt. Vernon columns consist of two vertical mouldings (ex:552). Appliques are often added to the capitals and breast plate. A dentil moulding is placed below the mantel shelf.

The Olympia
MTL-OLY

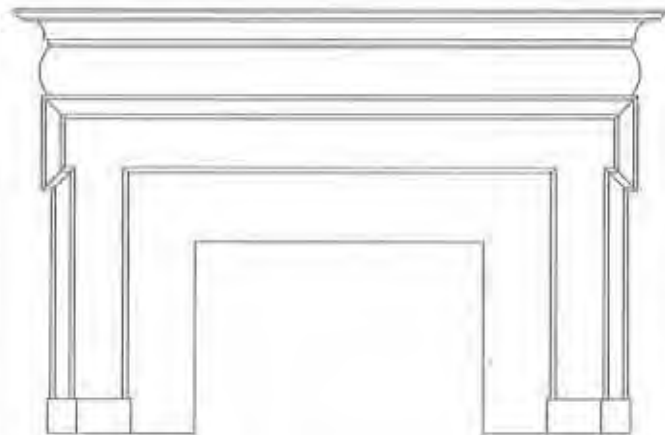

The Olympia features a large half round (ex: 414) below the mantel shelf. An asymmetrical moulding (ex:512) frames the mantel legs and breast board.

The Starwood
MTL-STA

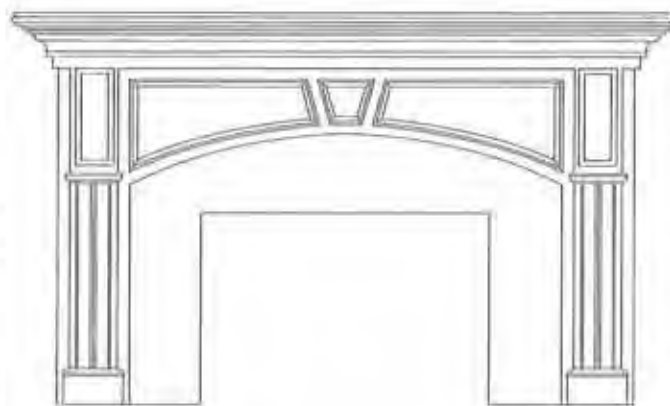

The Starwood's arched breast board has applied curved mouldings. The capitals are recessed panels and the columns are made from symmetrical mouldings.

The Vancouver
MTL-VAN

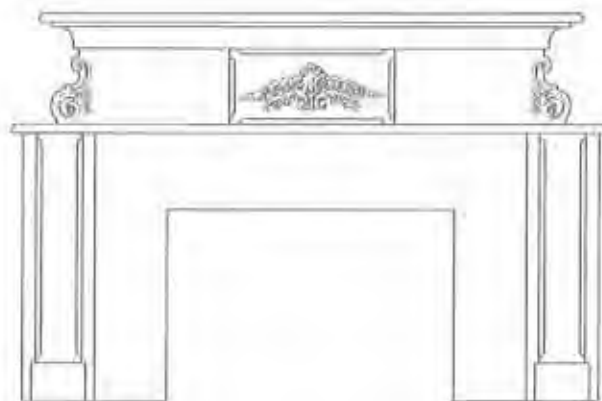

The Vancouver has decorative appliques on the shaped ends of the breast board and on the breast plate. Both the columns and the breast plate are stop fluted. A narrow shelf width makes the Vancouver ideal for situations with limited space.